

# Raccords à olive Série 1000 en laiton

Tube plastique, cuivre ou laiton Ø 4 - 6 - 8 - 10 - 12 mm  
 Raccordement: BSP (G1/8", G1/4"),  
 BSPT (R1/8", R1/4", R3/8", R1/2")

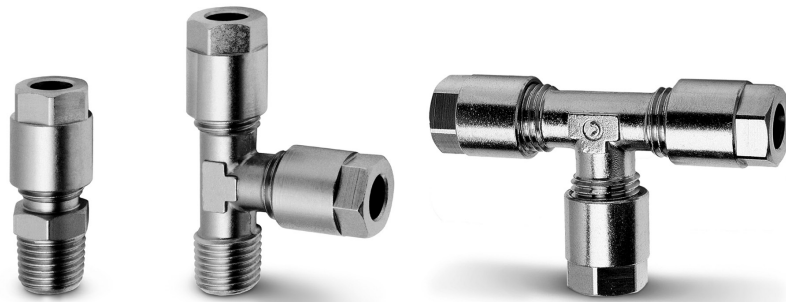

Les raccords à olive Série 1000 sont utilisables avec des tubes en matières plastiques mais aussi avec des tubes en cuivre, laiton, acier ou aluminium. Ces raccords sont destinés à des applications pneumatiques ou hydrauliques à basse pression.

Le siège, l'olive et l'écrou sont conformes à la norme DIN 3870-3861.

## CARACTERISTIQUES GENERALES

<b>Diamètre</b>	Ø 4 - 6 - 8 - 10 - 12 mm
<b>Raccordement</b>	Gaz conique ISO 7 ( BSPT ) - Gaz cylindrique ISO 228 ( BSP )
<b>Température</b>	( voir caractéristiques du tube utilisé )
<b>Tube utilisé</b>	cuivre recuit et tubes plastiques ( avec fourrure )
<b>Fluide</b>	Air comprimé et autres fluides basse pression
<b>Matériaux</b>	Laiton nickelé
<b>Pression</b>	max. 40 bar ( voir caractéristiques du tube utilisé )

## Raccord avec avec tube de liaison

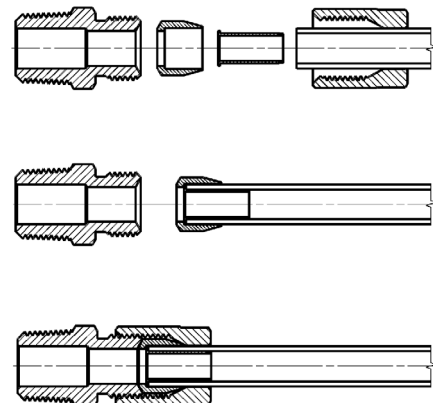

RACCORDS À OLIVE UNIVERSELS EN LAITON SÉRIE 1000

**Raccord Mod. 1050**

Droit Mâle Conique

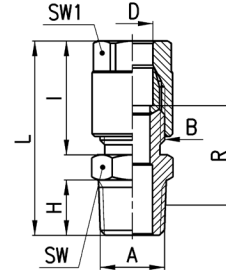

DIMENSIONS											
Mod.	D	A	B	H	I	L	R	SW	SW1	Poids (g)	
1050 4-1/8	4	R1/8	1/8	7,5	19	31	14	12	12	19	
1050 6-1/8	6	R1/8	1/8	7,5	19	31	14	12	12	18	
1050 6-1/4	6	R1/4	1/8	11	19	35	16,5	14	12	23	
1050 8-1/8	8	R1/8	1/4	7,5	23	35	15,5	14	14	29	
1050 8-1/4	8	R1/4	1/4	11	23	39	18	14	14	33	
1050 8-3/8	8	R3/8	1/4	11,5	23	39,5	18	17	14	40	
1050 10-1/4	10	R1/4	3/8	11	25,5	41,5	18	17	17	51	
1050 10-3/8	10	R3/8	3/8	11,5	25,5	42	18	17	17	55	
1050 10-1/2	10	R1/2	3/8	14	25,5	45	18	22	17	65	
1050 12-1/4	12	R1/4	M18x1,5	11	24,5	40,5	12	19	19	56	*
1050 12-3/8	12	R3/8	M18x1,5	11,5	24,5	41	12	19	19	58	*
1050 12-1/2	12	R1/2	M18x1,5	14	24,5	44	12	22	19	68	*

\* = avec olive bi-conique

RACCORDS À OLIVE UNIVERSELS EN LAITON SÉRIE 1000

**Raccord Mod. 1063**

Droit Femelle cylindrique

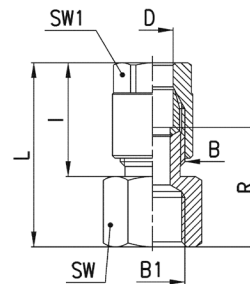

DIMENSIONS									
Mod.	D	B1	B	I	L	R	SW	SW1	Poids (g)
1063 4-1/8	4	G1/8	1/8	19	29	18,5	13	12	19
1063 6-1/8	6	G1/8	1/8	19	29	18,5	13	12	18
1063 6-1/4	6	G1/4	1/8	19	30,5	20	17	12	25
1063 8-1/8	8	G1/8	1/4	23	33	20	14	14	31
1063 8-1/4	8	G1/4	1/4	23	34,5	21,5	17	14	35

**Raccord Mod. 1020**

Coude Mâle Fixe Conique

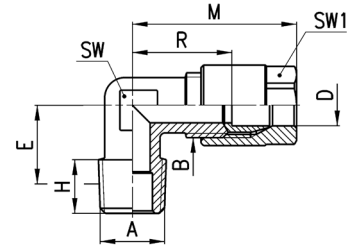

DIMENSIONS											
Mod.	D	A	B	E	H	M	R	SW	SW1	Poids (g)	
1020 4-1/8	4	R1/8	1/8	11,5	7,5	29,5	19	9	12	21	
1020 6-1/8	6	R1/8	1/8	11,5	7,5	29,5	19	9	12	19	
1020 6-1/4	6	R1/4	1/8	13,5	11	29,5	19	12	12	27	
1020 8-1/8	8	R1/8	1/4	11,5	7,5	33	20	11	14	35	
1020 8-1/4	8	R1/4	1/4	13,5	11	33	20	12	14	36	
1020 8-3/8	8	R3/8	1/4	15,5	11,5	35	22	14	14	50	
1020 10-1/4	10	R1/4	3/8	15	11	38	22,5	13	17	59	
1020 10-3/8	10	R3/8	3/8	15,5	11,5	38	22,5	14	17	58	
1020 10-1/2	10	R1/2	3/8	16	14	38	22,5	16	17	78	
1020 12-1/4	12	R1/4	M18x1,5	15	11	37	16,5	15	19	66	*
1020 12-3/8	12	R3/8	M18x1,5	15	11,5	37	16,5	15	19	66	*
1020 12-1/2	12	R1/2	M18x1,5	16	14	37	16,5	16	19	75	*

\* = avec olive bi-conique

RACCORDS À OLIVE UNIVERSELS EN LAITON SÉRIE 1000

**Raccord Mod. 1093**

Coude Femelle cylindrique

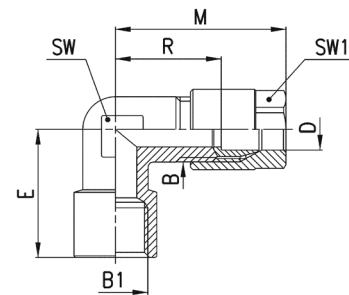

DIMENSIONS									
Mod.	D	B1	B	E	M	R	SW	SW1	Poids (g)
1093 4-1/8	4	G1/8	1/8	19	29,5	18,5	12	12	31
1093 6-1/8	6	G1/8	1/8	19	29,5	19	12	12	25
1093 6-1/4	6	G1/4	1/8	23	30,5	20	13	12	39
1093 8-1/8	8	G1/8	1/4	19	33	20	11	14	39
1093 8-1/4	8	G1/4	1/4	23	35	22	13	14	44

**Raccord Mod. 1000**

T Mâle au Centre Fixe Conique

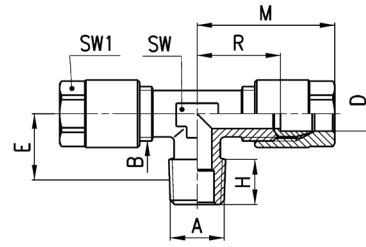

DIMENSIONS										
Mod.	D	A	B	E	H	M	R	SW	SW1	Poids (g)
1000 4-1/8	4	R1/8	1/8	11,5	7,5	29,5	19	9	12	35
1000 6-1/8	6	R1/8	1/8	11,5	7,5	29,5	19	9	12	33
1000 8-1/4	8	R1/4	1/4	13,5	11	33	20	12	14	63
1000 10-1/4	10	R1/4	3/8	15	11	38	22,5	13	17	104

**Raccord Mod. 1010**

T Renversé Fixe Conique

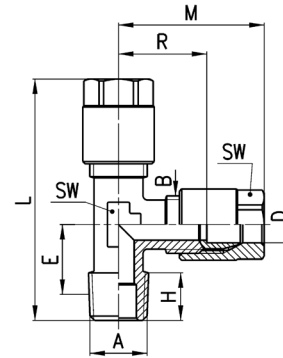

DIMENSIONS											
Mod.	D	A	B	E	H	L	M	R	SW	SW1	Poids (g)
1010 4-1/8	4	R1/8	1/8	11,5	7,5	48	29,5	19	9	12	37
1010 6-1/8	6	R1/8	1/8	11,5	7,5	48	29,5	19	9	12	33
1010 8-1/4	8	R1/4	1/4	13,5	11	54,5	33	20	12	14	61
1010 10-1/4	10	R1/4	3/8	15	11	61,5	38	22,5	13	17	103

**Raccord Mod. 1230**

Union Double Egale

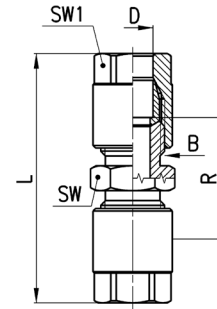

DIMENSIONS							
Mod.	D	B	L	R	SW	SW1	Poids (g)
1230 4	4	1/8	42,5	21,5	12	12	29
1230 6	6	1/8	42,5	21,5	12	12	26
1230 8	8	1/4	51	25	14	14	48
1230 10	10	3/8	56	25	17	17	83
1230 12	12	M18x1,5	54	13	19	19	140

\* = avec olive bi-conique

**Raccord Mod. 1250**

Union Double Traversée de Cloison

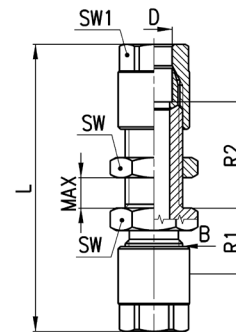

DIMENSIONS									
Mod.	D	B	L	R1	R2	MAX	SW	SW1	Poids (g)
1250 4	4	1/8	57,5	12,5	23	12	14	12	40
1250 6	6	1/8	57,5	13	23,5	12	14	12	38
1250 8	8	1/4	65	15	24	13	17	14	67
1250 10	10	3/8	72,5	15	26,5	13	22	17	119

**Raccord Mod. 1220**

Coude Egal

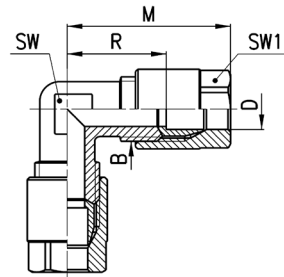

DIMENSIONS							
Mod.	D	B	M	R	SW	SW1	Poids (g)
1220 4	4	1/8	29,5	19	9	12	31
1220 6	6	1/8	29,5	19	9	12	29
1220 8	8	1/4	33	20	11	14	53
1220 10	10	3/8	38	22,5	14	17	92
1220 12	12	M18x1,5	37	16,5	16	19	99 *

\* = avec olive bi-conique

**Raccord Mod. 1210**

Té Egal

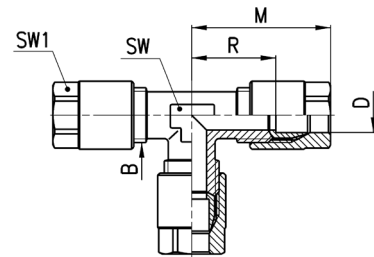

DIMENSIONS							
Mod.	D	B	M	R	SW	SW1	Poids (g)
1210 4	4	1/8	29,5	19	9	12	45
1210 6	6	1/8	29,5	19	9	12	42
1210 8	8	1/4	33	20	12	14	79
1210 10	10	3/8	38	22,5	13	17	133
1210 12	12	M18x1,5	37	16,5	16	19	144 *

\* = avec olive bi-conique

**Raccord Mod. 1170**

Banjo Simple

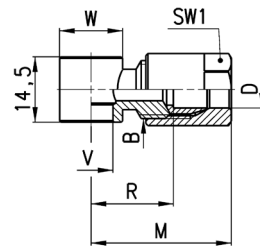

DIMENSIONS									
Mod.	D	B	R	M	V	W	SW1	Poids (g)	assemblage avec Mod.
1170 6-1/8	6	1/8	17.5	28	9.8	14	12	20	1631, 1635, SCU, SVU, SCO...
1170 6-1/4	6	1/8	20	30.5	13.2	18	12	24	1631, 1635, SCU, SVU, SCO...
1170 8-1/8	8	1/4	18	31	9.8	14	14	31	1635, SCU, SVU, SCO...

**Ecrou Mod. 1303**

Ecrou de blocage

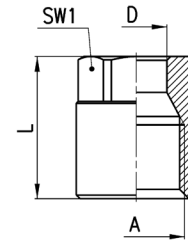

DIMENSIONS					
Mod.	D	A	L	SW1	Poids (g)
1303 4-1/8	4	1/8	15,5	12	8
1303 6-1/8	6	1/8	15,5	12	8
1303 8-1/4	8	1/4	19	14	14
1303 10-3/8	10	3/8	21,5	17	24
1303 12-M18x1,5	12	M18x1,5	19,5	19	27

**Olive Mod. 1310**

Olive et bi-cone

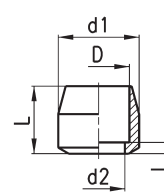

FIG. 1

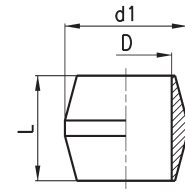

FIG. 2

DIMENSIONS						
Mod.	D	d1	d2	l	L	Poids (g)
1310 4	4	7,8	3	1	8	2
1310 6	6	7,8	4,5	1	7	1
1310 8	8	10,8	7	1,5	9	3
1310 10	10	13,8	9	1,5	11,5	5
1310 12-M18	12	16,3	12	-	11	6 *

Fig. 1 = olive

Fig. 2 = olive bi-conique

\* = avec olive bi-conique

**Accessoire Mod. 1320**

Fourrure

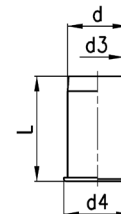

DIMENSIONS					
Mod.	d	d3	d4	L	Poids (g)
1320 4	4	3	5	12	1
1320 6	6	5	7	13	1
1320 8	8	7	9	14	1
1320 10	10	9	11	16	2