

Raccords instantanés série 6000 pour tube plastique

Tube Ø 3 (Micro seul.), 4, 6, 5, 8, 10,12, 14 et 16 mm
 Raccordement: métrique (M3, M5, M6, M7), BSP (G1/8, G1/4, G3/8, G1/2, G3/4), BSPT (R1/8, R1/4, R3/8, R1/2)

RACCORDS INSTANTANÉS POUR TUBE PLASTIQUE SÉRIE 6000



Les raccords instantanés de la série 6000 ont été conçus avec une griffe monobloc spéciale qui assure une étanchéité homogène sur toute la surface en contact du tube, assurant ainsi une grande fiabilité et une longue durée de vie, même après plusieurs connexions et déconnexions du tube. De nombreux types de filetages sont également disponibles : métrique, BSP et BSPT.

Les modèles Sprint® se caractérisent par une grande adaptabilité des filetages mâles avec filetages femelles parallèles BSP (ISO-228) même en présence de surfaces non planes ou irrégulières. Ceci est possible grâce à une bague en Téflon sur le filetage mâle, qui garantit une étanchéité parfaite entre les deux filetages.

La large gamme de ces raccords comprend la version LF ("Stop Fitting") qui est équipée d'un dispositif d'arrêt automatique interrompant le flux d'air lorsque le tube est déconnecté et le rétablissant lorsqu'il est reconnecté.

CARACTERISTIQUES GENERALES

Diamètre	Série 6000 micro : Ø 3 - 4 - 6 - 8 - 10 mm Série 6000 : Ø 4 à 16 mm
Raccordement	Série 6000 micro : M3 - M5 - M7 - G1/8 - G1/4 Série 6000 : Gaz conique ISO 7 (BSPT) Gas cylindrique ISO 228 (BSP) M5-M6 et autres filetages métriques sur demande NPT sur demande
Température	Série 6000 micro : -10 à + 80°C (voir caractéristiques du tube utilisé) Série 6000 : -20 à + 80°C (voir caractéristiques du tube utilisé)
Tube utilisé	PA 6, 11, 12 - PE - PU
Fluide	Air comprimé (pour tout autre fluide, consulter nos techniciens)
Matériaux	Modèle standard : Corps et pince laiton OT nickelé - Joint torique NBR bague d'étanchéité PTFE / NBR / PA Modèle avec clapet anti-retour : Corps et pince laiton OT nickelé Clapet en laiton, ressort en inox joint torique en NBR, bague d'étanchéité PTFEA
Pression	Modèle standard : min -0,9 max 16 bar (voir tube) Modèle avec clapet anti-retour : 0 ÷ 16 bar

Raccord avec guidage du tube

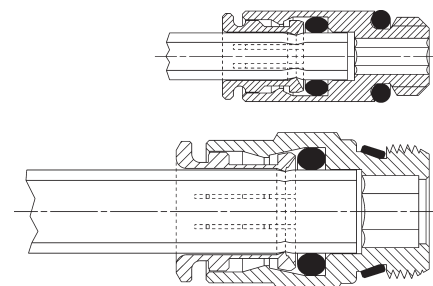

Raccord Mod. S6510

Droit Mâle Sprint®



DIMENSIONS										
Mod.	A	D	C	F	G	H	L	SW	SW1	Poids (g)
S6510 4-1/8	4	G1/8	3.8	8.8	13.2	5.5	18	12	2.5	9
S6510 4-1/4	4	G1/4	5.5	8.8	15.2	7	19.5	14	2.5	15
S6510 5-1/8	5	G1/8	3.8	9.8	13.2	5.5	19	12	3	8
S6510 5-1/4	5	G1/4	5.5	9.8	15.2	7	20	14	3	14
S6510 6-1/8	6	G1/8	6	11.7	13.2	5.5	22	12	4	10
S6510 6-1/4	6	G1/4	5.5	11.7	15.2	7	21	14	4	14
S6510 6-3/8	6	G3/8	6.5	11.7	20.5	8	22.5	19	4	27
S6510 8-1/8	8	G1/8	7.5	13.7	15.2	5.5	25	14	5	13
S6510 8-1/4	8	G1/4	6.5	13.7	15.2	7	24	14	6	14
S6510 8-3/8	8	G3/8	6	13.7	20.5	8	23.5	19	6	25
S6510 8-1/2	8	G1/2	7.5	13.7	24.5	9	25	22	6	43
S6510 10-1/4	10	G1/4	8.3	15.4	18.5	7	28.5	17	7	23
S6510 10-3/8	10	G3/8	5.3	15.4	20.5	8	25.5	19	8	27
S6510 10-1/2	10	G1/2	4.8	16	24.5	9	25	22	8	39
S6510 12-1/4	12	G1/4	10.3	18.3	20.5	7	29.5	19	7	26
S6510 12-3/8	12	G3/8	9.3	18.3	20.5	8	28.5	19	9	30
S6510 12-1/2	12	G1/2	5.8	18.3	24.5	9	25	22	10	36
S6510 14-3/8	14	G3/8	10.3	20.5	24.5	8	30.5	22	9	42
S6510 14-1/2	14	G1/2	6.3	20.5	24.5	9	26.5	22	12	34
S6510 16-1/2	16	G1/2	9	23.5	26.5	9	32	24	-	42
S6510 16-3/4	16	G3/4	3.5	23.5	27.3	9	26.5	24	-	46

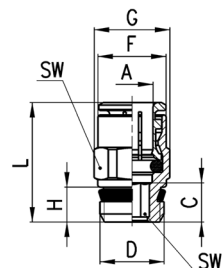

RACCORDS INSTANTANÉS POUR TUBE PLASTIQUE SÉRIE 6000

Raccord Mod. S6510...-LF

Droit Mâle Sprint® avec clapet anti-retour

Cette version interrompt le flux d'air lorsque le tube est déconnecté et le restaure une fois reconnecté.

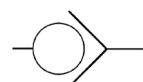
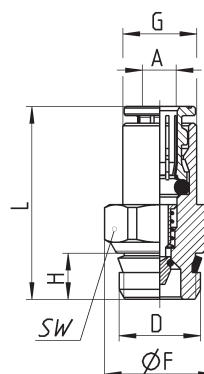

DIMENSIONS								
Mod.	A	D	F	G	H	L	SW	poid (g)
S6510 4-1/8-LF	4	G1/8	13.2	8.8	5.5	23	12	11
S6510 6-1/8-LF	6	G1/8	13.2	11.7	6	30.5	12	15

Raccord Mod. 6512 Micro

Droit Mâle Métrique-Cylindrique

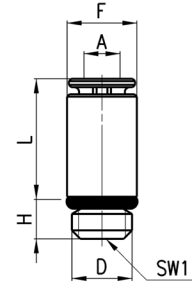

RACCORDS INSTANTANÉS POUR TUBE PLASTIQUE SÉRIE 6000

DIMENSIONS							
Mod.	A	D	F	H	L	SW1	Poids (g)
6512 3-M3	3	M3	5.8	2.5	10.2	1.5	1 *
6512 3-M5	3	M5	5.8	3.5	10	2	1 •
6512 4-M7-M	4	M7	9.4	5	17.5	2.5	5 •
6512 4-1/8-M	4	G1/8	11.2	5	13	2.5	9 •,Y
6512 6-M7-M	6	M7	10.4	5	17	4	7 •
6512 6-1/8-M	6	G1/8	11.2	5	14	4	7 •,Y
6512 8-1/8-M	8	G1/8	12.4	5	18.5	5	10 •,Y
6512 10-1/4-M	10	G1/4	14.8	6	21	7	16 •

* = Avec joint plat
• = Avec joint torique

Raccord Mod. 6512

Nouvelles tailles

Droit Mâle Métrique-Cylindrique

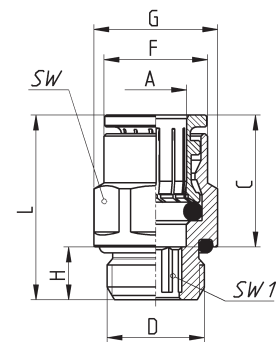

DIMENSIONS										
Mod.	A	D	C	F	G	H	L	SW	SW1	Poids (g)
6512 4-M5	4	M5	14.0	7.8	8.8	4	20	8	2	4
6512 4-M6	4	M6	14.0	8.8	9.9	4.5	20.5	9	2.5	6
6512 4-1/8	4	G1/8	14.0	8.8	13.5	6	19	12	2.5	10
6512 4-1/4	4	G1/4	14.0	8.8	16.4	7	20.5	15	2.5	14
6512 5-M5	5	M5	15.0	8.8	9.9	4	21	9	2	5
6512 6-M5	6	M5	16.0	11.7	13.2	4	22	12	2	8
6512 6-M6	6	M6	16.0	11.7	13.2	4.5	22.5	12	2.5	8
6512 6-1/8	6	G1/8	16.0	11.7	13.5	6	21	12	4	10
6512 6-1/4	6	G1/4	16.0	11.7	16.4	7	22	15	4	13
6512 8-1/8	8	G1/8	17.5	13.7	15.2	6	26	14	5	15
6512 8-1/4	8	G1/4	17.5	13.7	16.4	7	24.5	15	6	17
6512 8-3/8	8	G3/8	17.5	13.7	20.5	7	23	19	6	27
6512 10-1/4	10	G1/4	20.2	15.4	18.5	7	30	17	7	26
6512 10-3/8	10	G3/8	20.2	15.4	20.5	7	24.5	19	8	27
6512 10-1/2	10	G1/2	20.2	15.4	24.8	8	25	22	8	39
6512 12-1/4	12	G1/4	19.2	18.3	20.5	7	29.5	19	7	29
6512 12-3/8	12	G3/8	19.2	18.3	20.5	7	24	19	9	24
6512 12-1/2	12	G1/2	19.2	18.3	24.8	8	24.5	22	9	37
6512 14-3/8	14	G3/8	20.2	20.5	24.5	7	30.5	22	10	38
6512 14-1/2	14	G1/2	20.2	20.5	24.8	8	25.5	22	10	35
6512 16-1/2	16	G1/2	23.0	23.5	26.5	8	33.5	24	-	49

Raccord Mod. 6463

Droit Femelle

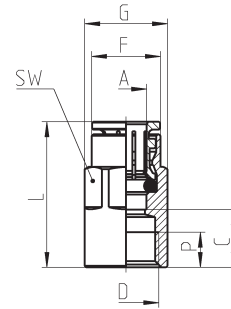

DIMENSIONS									
Mod.	A	D	C	F	G	L	P (min)	SW	Poids (g)
6463 4-M5	4	M5	6.5	7.8	8.8	20.5	4.5	9	8
6463 4-1/8	4	G1/8	10	9	13	24	6	12	14
6463 5-1/8	5	G1/8	10	9.8	13	25	6	12	14
6463 6-1/8	6	G1/8	10	11.7	13	26	6	12	14
6463 6-1/4	6	G1/4	11.5	11.9	16.5	27.5	7	15	23
6463 8-1/8	8	G1/8	9.5	13.7	15.2	27	6	14	16
6463 8-1/4	8	G1/4	11.5	13.7	16.5	29	7	15	23
6463 10-1/4	10	G1/4	11.3	15.4	18.5	31.5	7	17	29

RACCORDS INSTANTANÉS POUR TUBE PLASTIQUE SÉRIE 6000

Raccords Mod. S6520

Coude Mâle Orientable Sprint®

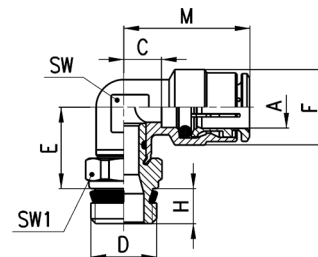

DIMENSIONS										
Mod.	A	D	C	E	F	H	M	SW	SW1	Poids (g)
S6520 4-1/8	4	G1/8	3.5	14.5	9	5.5	17.5	8	12	17
S6520 4-1/4	4	G1/4	3.5	14.5	9	7	17.5	8	14	23
S6520 5-1/8	5	G1/8	5.5	14.5	10	5.5	20.5	9	12	17
S6520 5-1/4	5	G1/4	5.5	14.5	10	7	20.5	9	14	23
S6520 6-1/8	6	G1/8	4	15	12.7	5.5	20	9	12	20
S6520 6-1/4	6	G1/4	4	15	12.7	7	20	9	14	23
S6520 6-3/8	6	G3/8	4	15.5	12.7	8	20	9	19	33
S6520 8-1/8	8	G1/8	5	16	14.2	5.5	22.5	11	12	22
S6520 8-1/4	8	G1/4	5	16	14.2	7	22.5	11	14	26
S6520 8-3/8	8	G3/8	5	16.5	14.2	8	22.5	11	19	41
S6520 8-1/2	8	G1/2	5	17	14.2	9	22.5	11	22	48
S6520 10-1/4	10	G1/4	5.8	18.5	16.5	7	26	13	14	32
S6520 10-3/8	10	G3/8	5.8	19	16.5	8	26	13	19	43
S6520 10-1/2	10	G1/2	5.8	19.5	16.5	9	26	13	22	62
S6520 12-1/4	12	G1/4	7.3	20	19.5	7	26.5	15	17	49
S6520 12-3/8	12	G3/8	7,3	20	19,5	8	26,5	15	19	48
S6520 12-1/2	12	G1/2	7,3	20,5	19,5	9	26,5	15	22	70
S6520 14-3/8	14	G3/8	8,3	21	21,5	8	28,5	17	19	74
S6520 14-1/2	14	G1/2	8,3	21,5	21,5	9	28,5	17	22	78

Raccord Mod. 6522 Micro

Coude Mâle Orientable Métrique-Cylindrique

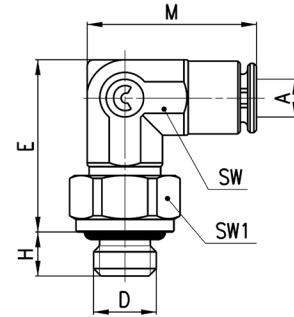

RACCORDS INSTANTANÉS POUR TUBE PLASTIQUE SÉRIE 6000

DIMENSIONS									
Mod.	A	D	E	H	M	SW	SW1	Poids (g)	
6522 3-M3	3	M3	13.7	2.5	13.7	6	6	4	*
6522 3-M5	3	M5	13.7	3.5	13.7	6	8	5	•

* = Avec joint plat
• = Avec joint torique

Raccord Mod. 6522

Nouvelles tailles

Coude Mâle Orientable Métrique-Cylindrique

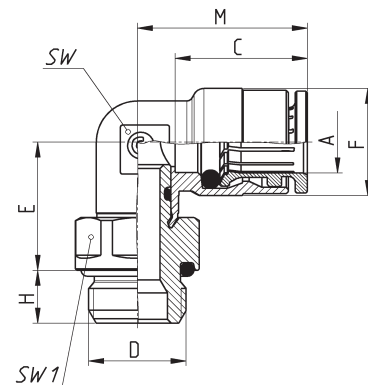

DIMENSIONS										
Mod.	A	D	C	E	F	H	M	SW	SW1	Poids (g)
6522 4-M5	4	M5	14.0	12.5	9	4	17.5	8	8	12
6522 4-1/8	4	G1/8	14.0	14.5	9	6	17.5	8	12	15
6522 4-1/4	4	G1/4	14.0	15.5	9	7	17.5	8	15	25
6522 5-M5	5	M5	15.0	12.5	10	4	20.5	9	8	13
6522 6-M5	6	M5	16.0	13	12.7	4	20	9	10	14
6522 6-1/8	6	G1/8	16.0	15	12.7	6	20	9	12	19
6522 6-1/4	6	G1/4	16.0	16	12.7	7	20	9	15	27
6522 8-1/8	8	G1/8	17.5	16	14.2	6	22.5	11	12	22
6522 8-1/4	8	G1/4	17.5	17	14.2	7	22.5	11	15	28
6522 8-3/8	8	G3/8	17.5	17	14.2	7	22.5	11	19	45
6522 10-1/4	10	G1/4	20.2	19.5	16.5	7	26	13	15	41
6522 10-3/8	10	G3/8	20.2	19.5	16.5	7	26	13	19	45
6522 10-1/2	10	G1/2	20.2	20.5	16.5	8	26	13	22	53
6522 12-1/4	12	G1/4	19.2	20	19.5	7	26.5	15	17	51
6522 12-3/8	12	G3/8	19.2	20.5	19.5	7	26.5	15	19	56
6522 12-1/2	12	G1/2	19.2	21.5	19.5	8	26.5	15	22	58
6522 14-3/8	14	G3/8	20.2	21.5	21.5	7	28.5	17	19	53
6522 14-1/2	14	G1/2	20.2	22.5	21.5	8	28.5	17	22	61

Raccord Mod. S6500

Coude Mâle Fixe
Métrique

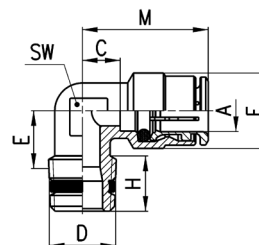

DIMENSIONS									
Mod.	A	D	C	E	F	H	M	SW	Poids (g)
S6500 4-1/8	4	R1/8	3.5	8.5	9	7.5	17.5	8	9
S6500 4-1/4	4	R1/4	5	11.5	9	12	19	9	13
S6500 5-1/8	5	R1/8	5.5	8.5	10	7.5	20.5	9	13
S6500 5-1/4	5	R1/4	5.5	11.5	10	12	20.5	9	17
S6500 6-1/8	6	R1/8	4	9	12.7	7.5	20	9	15
S6500 6-1/4	6	R1/4	4	11.5	12.7	12	20	9	16
S6500 8-1/8	8	R1/8	5	10.5	14.2	6.5	22.5	11	18
S6500 8-1/4	8	R1/4	5	11.5	14.2	12.5	22.5	11	21
S6500 8-3/8	8	R3/8	7	13	14.2	11.5	24.5	12	25
S6500 10-1/4	10	R1/4	5.8	13	16.5	11.5	26	13	33
S6500 10-3/8	10	R3/8	5.8	13	16.5	12	26	13	33
S6500 12-1/4	12	R1/4	7.3	14.5	19.5	11	26.5	15	46
S6500 12-3/8	12	R3/8	7.3	13.5	19.5	11.5	26.5	15	39

RACCORDS INSTANTANÉS POUR TUBE PLASTIQUE SÉRIE 6000

Raccord Mod. 6525

Coude Mâle Orientable Haut Sprint®

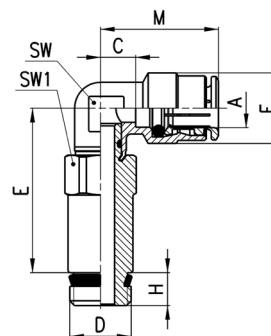

DIMENSIONS										
Mod.	A	D	C	E	F	H	M	SW	SW1	Poids (g)
6525 6-1/8	6	G1/8	4	33.8	12.7	5.5	20	9	12	34
6525 6-1/4	6	G1/4	4	34	12.7	7	20	9	14	47
6525 8-1/8	8	G1/8	5	34.8	14.2	5.5	22.5	11	12	35
6525 8-1/4	8	G1/4	5	35	14.2	7	22.5	11	14	50

Raccord Mod. 6621 Micro



Ens. Banjo Simple Orientable
Métrique

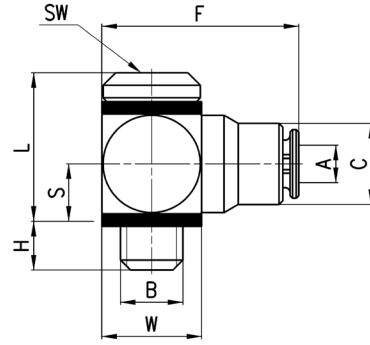

DIMENSIONS										
Mod.	A	B	C	F	H	L	S	W	SW	Poids (g)
6621 3-M3	3	M3	5.8	14.2	2.5	9.3	3.5	6	1.5	5
6621 3-M5	3	M5	6.5	16	3.2	11.9	4.8	8	2	6

Raccord Mod. 6501 4-M5



Coude Mâle Fixe
Métrique

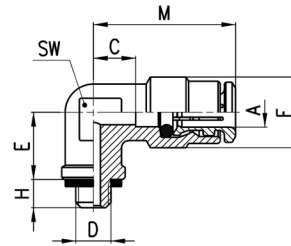

DIMENSIONS									
Mod.	A	D	C	E	F	H	M	SW	Poids (g)
6501 4-M5	4	M5	3.5	6	9	4	17.5	8	11

Raccord Mod. S6430

T Mâle au Centre
Cylindrique Sprint®

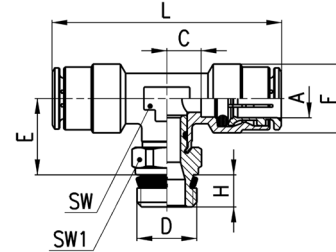

DIMENSIONS										
Mod.	A	D	C	E	F	H	L	SW	SW1	Poids (g)
S6430 4-1/8	4	G1/8	3.5	14.5	9	5.5	35	8	12	18
S6430 5-1/8	5	G1/8	5.5	14.5	10	5.5	41	9	12	24
S6430 5-1/4	5	G1/4	5.5	14.5	10	7	41	9	14	30
S6430 6-1/8	6	G1/8	4	15	12.7	5.5	40	9	12	28
S6430 6-1/4	6	G1/4	4	15	12.7	7	40	9	14	33
S6430 8-1/8	8	G1/8	5	16	14.2	5.5	45	11	12	37
S6430 8-1/4	8	G1/4	5	16	14.2	7	45	11	14	42
S6430 8-3/8	8	G3/8	5	16.5	14.2	8	45	11	19	51
S6430 10-1/4	10	G1/4	5.8	18.5	16.5	7	52	13	14	56
S6430 10-3/8	10	G3/8	5.8	19	16.5	8	52	13	19	67
S6430 10-1/2	10	G1/2	5.8	19.5	16.5	9	52	13	22	85
S6430 12-1/4	12	G1/4	7.3	20	19.5	7	53	15	17	60
S6430 12-3/8	12	G3/8	7.3	20	19.5	8	53	15	19	65
S6430 12-1/2	12	G1/2	7.3	20.5	19.5	9	53	15	22	89
S6430 14-1/2	14	G1/2	8.3	21.5	21.5	9	57	17	22	88

RACCORDS INSTANTANÉS POUR TUBE PLASTIQUE SÉRIE 6000

Raccord Mod. 6432 Micro

T Mâle au Centre Orientable
Métrique-Cylindrique

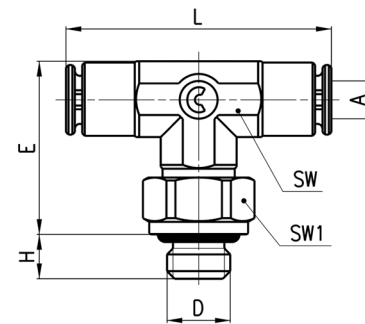

DIMENSIONS									
Mod.	A	D	E	H	L	SW	SW1	Poids (g)	
6432 3-M3	3	M3	13.7	2.5	21.4	6	6	5	*
6432 3-M5	3	M5	13.7	3.5	21.4	6	8	6	•

* = Avec joint plat
• = Avec joint torique

Raccord Mod. 6432

T Mâle au Centre Orientable
Métrique-Cylindrique

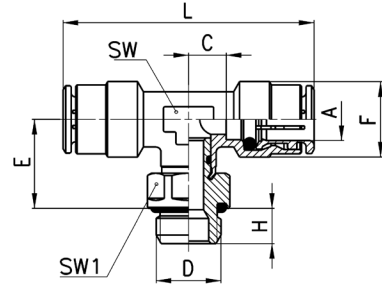

DIMENSIONS										
Mod.	A	D	C	E	F	H	L	SW	SW1	Poids (g)
6432 4-M5	4	M5	3.5	12.5	9	4	35	8	8	14
6432 4-1/8	4	G1/8	3.5	14.5	9	6	35	8	12	19
6432 5-M5	5	M5	5.5	12.5	10	4	41	9	8	19
6432 6-1/8	6	G1/8	4	15	12.7	6	40	9	12	29
6432 6-1/4	6	G1/4	4	16	12.7	7	40	9	15	30
6432 8-1/8	8	G1/8	5	16	14.2	6	45	11	12	37
6432 8-1/4	8	G1/4	5	17	14.2	7	45	11	15	39
6432 8-3/8	8	G3/8	5	17	14.2	7	45	11	19	55
6432 10-1/4	10	G1/4	5.8	19.5	16.5	7	52	13	15	59
6432 10-3/8	10	G3/8	5.8	19.5	16.5	7	52	13	19	56
6432 12-1/4	12	G1/4	7.3	20	19.5	7	53	15	17	60
6432 12-3/8	12	G3/8	7.3	20.5	19.5	7	53	15	19	80

RACCORDS INSTANTANÉS POUR TUBE PLASTIQUE SÉRIE 6000

Raccord Mod. S6440

T Mâle Renversé Orientable
Cylindrique Sprint®

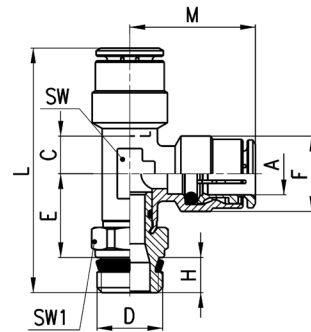

DIMENSIONS											
Mod.	A	D	C	E	F	H	L	M	SW	SW1	Poids (g)
S6440 4-1/8	4	G1/8	3.5	14.5	9	5.5	37.5	17.5	8	12	23
S6440 5-1/8	5	G1/8	5.5	14.5	10	5.5	40.5	20.5	9	12	24
S6440 6-1/8	6	G1/8	4	15	12.7	5.5	40.5	20	9	12	26
S6440 6-1/4	6	G1/4	4	15	12.7	7	42	20	9	14	31
S6440 8-1/8	8	G1/8	5	16	14.2	5.5	44	22.5	11	12	37
S6440 8-1/4	8	G1/4	5	16	14.2	7	45.5	22.5	11	14	35
S6440 8-3/8	8	G3/8	5	16.5	14.2	8	47	22.5	11	19	52
S6440 10-1/4	10	G1/4	5.8	18.5	16.5	7	51.5	26	13	14	43
S6440 10-3/8	10	G3/8	5.8	18.5	16.5	8	53	26	13	19	66
S6440 12-3/8	12	G3/8	7.3	19.5	19.5	8	54.5	26.5	15	19	65
S6440 14-1/2	14	G1/2	8.3	21.5	21.5	9	59	28.5	17	22	88

Raccord Mod. 6442 Micro



T Mâle Renversé Orientable Métrique

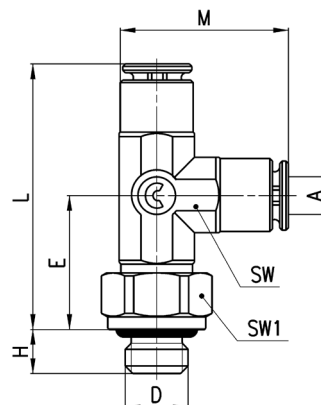

DIMENSIONS										
Mod.	A	D	E	H	L	M	SW	SW1	Poids (g)	
6442 3-M3	3	M3	10.7	2.5	21.4	13.7	6	6	5	*
6442 3-M5	3	M5	12.2	3.5	21.4	13.7	6	8	6	•

* = Avec joint plat
• = Avec joint torique

RACCORDS INSTANTANÉS POUR TUBE PLASTIQUE SÉRIE 6000

Raccord Mod. 6442



T Mâle Renversé Orientable Métrique

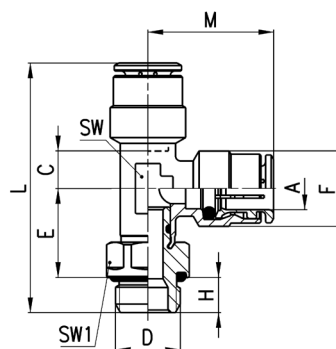

DIMENSIONS											
Mod.	A	D	C	E	F	H	L	M	SW	SW1	Poids (g)
6442 4-M5	4	M5	3.5	12.5	9	4	34	17.5	8	8	18
6442 4-1/8	4	G1/8	3.5	14.5	9	6	38	17.5	8	12	19
6442 5-M5	5	M5	5.5	12.5	10	4	36.5	20.5	9	8	19
6442 6-1/8	6	G1/8	4	15	12.7	6	41	20	9	12	26
6442 6-1/4	6	G1/4	4	16	12.7	7	43	20	9	15	36
6442 8-1/8	8	G1/8	5	16	14.2	6	44.5	22.5	11	12	31
6442 8-1/4	8	G1/4	5	17	14.2	7	46.5	22.5	11	15	42
6442 8-3/8	8	G3/8	5	17	14.2	7	46.5	22.5	11	19	50
6442 10-1/4	10	G1/4	5.8	19.5	16.5	7	52.5	26	13	15	46
6442 10-3/8	10	G3/8	5.8	19.5	16.5	7	52.5	26	13	19	66
6442 12-1/4	12	G1/4	7.3	20	16.5	7	53.5	26.5	15	17	73
6442 12-3/8	12	G3/8	7.3	20.5	19.5	7	54	26.5	15	19	64

Raccord Mod. 6452 Micro



Y Mâle Orientable Métrique

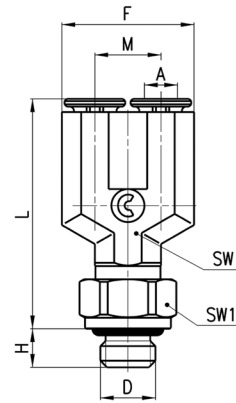

DIMENSIONS										
Mod.	A	D	F	H	L	M	SW	SW1	Poids (g)	
6452 3-M3	3	M3	12	2.5	20.9	6	6	6	6	*
6452 3-M5	3	M5	12	3.5	20.9	6	6	8	7	•

* = Avec joint plat
• = Avec joint torique

Raccord Mod. 6451 - S6450



Mod. 6451: Y Mâle Orientable Métrique

Mod. S6450: Y Mâle Orientable Sprint®

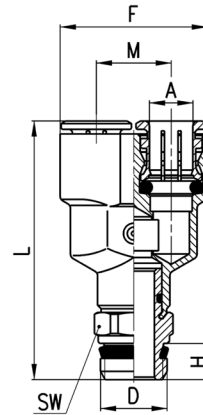

DIMENSIONS									
Mod.	A	D	F	H	L	M	SW	Poids (g)	
6451 4-M5	4	M5	18	4	26.5	9	-	17	*
6451 6-M5	6	M5	24.5	4	29.5	12.5	-	27	*
S6450 4-1/8	4	G1/8	18	5.5	38	9	12	23	
S6450 6-1/8	6	G1/8	24.5	5.5	41.5	12.5	12	33	
S6450 8-1/8	8	G1/8	28.5	5.5	48.5	14.5	14	48	
S6450 8-1/4	8	G1/4	28.5	7	50	14.5	14	50	

* = non orientable avec joint plat

Raccord Mod. 6622



Ens. Banjo Simple Orientable
Cylindrique

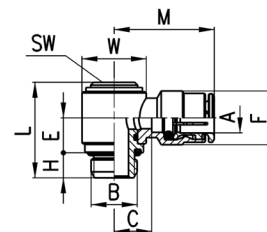

DIMENSIONS											
Mod.	A	B	C	E	F	H	L	M	SW	W	Poids (g)
6622 4-M5	4	M5	4	5.7	8.8	4	15.8	18	2.5	Ø 8	10
6622 4-1/8	4	G1/8	7.5	10.2	9	5	25	21.5	4	Ø 14	22
6622 6-1/8	6	G1/8	8	10.2	12.7	5	25	24	4	Ø 14	24
6622 6-1/4	6	G1/4	10	9.1	12.7	6	25.3	26	5	Ø 18	35
6622 8-1/8	8	G1/8	8	10.2	14.2	5	25	25.5	4	Ø 14	28
6622 8-1/4	8	G1/4	10	9.1	14.2	6	25.3	27.5	5	Ø 18	39
6622 10-1/4	10	G1/4	8.8	9.1	16.5	6	25.3	29	5	Ø 18	42

* = Ens. Banjo Simple Orientable
Métrique

Raccord Mod. 6632

Ens. Banjo Double Cylindrique

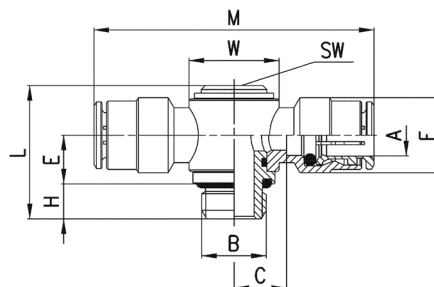

DIMENSIONS											
Mod.	A	B	C	E	F	H	L	M	W	SW	Poids (g)
6632 4-1/8	4	G1/8	7.5	10.2	9	5	25	43	∅14	4	24
6632 6-1/8	6	G1/8	8	10.2	12.7	5	25	48	∅14	4	33
6632 6-1/4	6	G1/4	10	9.1	12.7	6	25.3	52	∅18	5	35
6632 8-1/8	8	G1/8	8	10.2	14.2	5	25	51	∅14	4	39
6632 8-1/4	8	G1/4	10	9.1	14.2	6	25.3	55	∅18	5	40
6632 10-1/4	10	G1/4	8.8	9.1	16.5	6	25.3	58	∅18	5	50

Raccord Mod. 6620

Banjo double

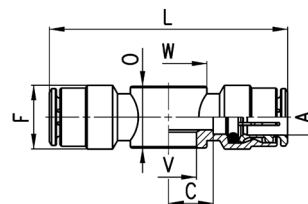

DIMENSIONS									
Mod.	A	C	F	L	O	V	W	Poids (g)	assemblage avec Mod.
6620 4-M5	4	5	9	38	9	5.1	∅9	13	SCU, SVU, SCO...
6620 4-1/8	4	7.5	9	43	14.5	9.8	∅14	19	1631, 1635, SCU, SVU, SCO...
6620 6-1/8	6	8	12.7	48	14.5	9.8	∅14	24	1631, 1635, SCU, SVU, SCO...
6620 6-1/4	6	10	12.7	52	14.5	13.2	∅18	26	1631, 1635, SCU, SVU, SCO...
6620 8-1/8	8	8	14.2	51	14.5	9.8	∅14	32	1631, 1635, SCU, SVU, SCO...
6620 8-1/4	8	10	14.2	55	14.5	13.2	∅18	34	1631, 1635, SCU, SVU, SCO...

Raccord Mod.1631 complet avec joints plats

- 01... = Vis Simple Etage
- 02... = Vis Double Etage
- 03... = Vis Triple Etage



Mod.
1631 01-
1631 02-
1631 03-

Désignation et encombrements page
2.05.09

Raccord Mod. 6610

Banjo Simple

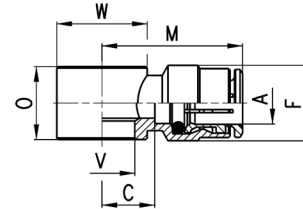

DIMENSIONS									
Mod.	A	C	F	M	O	V	W	Poids (g)	assemblage avec Mod.
6610 4-M5	4	5	9	19	9	5.1	9	9	1631
6610 4-M6	4	5	9	19	9	5.1	9	8	SCU, SVU, SCO...
6610 4-1/8	4	7.5	9	21.5	14.5	9.8	Ø 14	14	1631, 1635, SCU, SVU, SCO...
6610 5-M5	5	5	10	20	9	5.1	9	9	1631
6610 5-M6	5	5	10	20	9	5.1	9	8	SCU, SVU, SCO...
6610 5-1/8	5	8	10	23	14.5	9.8	Ø 14	16	1631, 1635, SCU, SVU, SCO...
6610 6-M5	6	6.5	12.7	22.5	9	5.1	Ø 10	12	1631
6610 6-M6	6	6.5	12.7	22.5	9	5.1	Ø 10	12	SCU, SVU, SCO...
6610 6-1/8	6	8	12.7	24	14.5	9.8	Ø 14	16	1631, 1635, SCU, SVU, SCO...
6610 6-1/4	6	10	12.7	26	14.5	13.2	Ø 18	19	1631, 1635, SCU, SVU, SCO...
6610 8-1/8	8	8	14.2	25.5	14.5	9.8	Ø 14	19	1631, 1635, SCU, SVU, SCO...
6610 8-1/4	8	10	14.2	27.5	14.5	13.2	Ø 18	22	1631, 1635, SCU, SVU, SCO...
6610 8-3/8	8	11	14.2	28.5	14.5	16.7	Ø 21	23	1631, 1635, SCU, SVU, SCO...
6610 10-1/4	10	8.8	16.5	29	14.5	13.2	Ø 18	22	1635, SCU, SVU, SCO...
6610 10-3/8	10	10.3	16.5	30.5	14.5	16.7	Ø 21	23	1635, SCU, SVU, SCO...
6610 12-1/2	12	12,8	16,5	32	14,5	21	Ø 26	37	1635

RACCORDS INSTANTANÉS POUR TUBE PLASTIQUE SÉRIE 6000

Raccord Mod. 6811

Adaptateur Mâle Cylindrique Sprint®

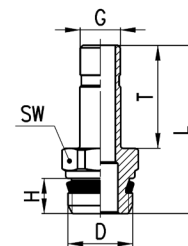

DIMENSIONS							
Mod.	G	D	H	T	L	SW	Poids (g)
6811 4-M5	4	M5	4	16.5	24.5	8	3 *
6811 4-1/8	4	G1/8	5.5	16.5	27.8	12	10
6811 5-1/8	5	G1/8	5.5	18	29.3	12	9
6811 5-1/4	5	G1/4	7	18	31	14	11
6811 6-1/8	6	G1/8	5.5	18	29.3	12	10
6811 6-1/4	6	G1/4	7	18	31	14	12
6811 8-1/8	8	G1/8	5.5	20.5	31.8	12	12
6811 8-1/4	8	G1/4	7	20.5	33.5	14	13
6811 10-1/4	10	G1/4	7	23	36	14	16
6811 10-3/8	10	G3/8	8	23	37.3	19	25
6811 12-3/8	12	G3/8	8	24	38.3	19	25
6811 14-1/2	14	G1/2	9	28	44	22	39

* = avec joint torique

Raccord Mod. S6110



Coude Mâle à 45° Orientable
Cylindrique Sprint®

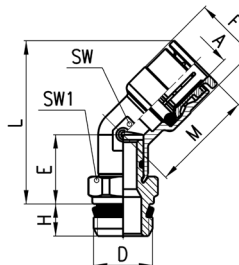

DIMENSIONS										
Mod.	A	D	E	F	H	L	M	SW	SW1	Poids (g)
S6110 6-1/8	6	G1/8	14	12.7	5.5	32.5	20.5	11	12	21
S6110 6-1/4	6	G1/4	14	12.7	7	34.5	20.5	11	14	25
S6110 8-1/8	8	G1/8	14	14.2	5.5	32.5	22.5	11	12	21
S6110 8-1/4	8	G1/4	14	14.2	7	34.5	22.5	11	14	26
S6110 8-3/8	8	G3/8	14.5	14.2	8	35	22.5	11	19	38
S6110 10-1/4	10	G1/4	15.5	16.5	7	39.5	26.5	15	17	39
S6110 10-3/8	10	G3/8	15.5	16.5	8	39.5	26.5	15	19	44
S6110 10-1/2	10	G1/2	16	16.5	9	40	26.5	15	22	57
S6110 12-1/4	12	G1/4	15.5	19.5	7	40.5	26.5	15	17	41
S6110 12-3/8	12	G3/8	15.5	19.5	8	40.5	26.5	15	19	46
S6110 12-1/2	12	G1/2	16	19.5	9	41	26.5	15	22	59

RACCORDS INSTANTANÉS POUR TUBE PLASTIQUE SÉRIE 6000

Raccord Mod. 6590 Micro

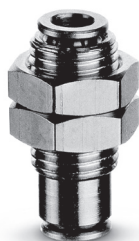

Traversée de Cloison

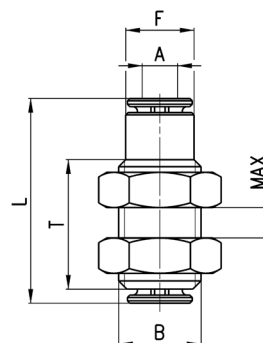

DIMENSIONS							
Mod.	A	B	F	L	MAX	T	Poids (g)
6590 3	3	M7x0.75	5.8	18.4	5	11.4	4

Raccord Mod. 6590

Traversée de Cloison

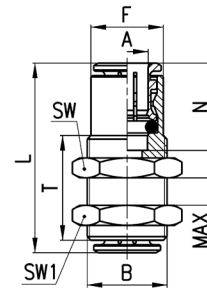

DIMENSIONS										
Mod.	A	B	F	L	N	MAX	SW	SW1	T	Poids (g)
6590 4	4	M10x1	8.8	29	14	10.5	14	14	20	16
6590 5	5	M12x1	9.8	31	15	10.5	17	17	20	25
6590 6	6	M14x1	12.5	33	16	10.5	17	17	20	28
6590 8	8	M16x1	14.5	36	17.5	11.5	19	19	21	35
6590 10	10	M18x1	16.3	41.5	20.2	13	22	22	23.5	51
6590 12	12	M20x1	18.8	39.5	19.2	14.5	24	24	25	56
6590 14	14	M22x1	20.5	41.5	20.2	17.5	27	27	30	82

Raccord Mod. 6580 Micro

Union Double Inégale

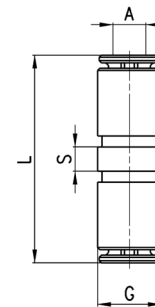

DIMENSIONS					
Mod.	A	G	L	S	Poids (g)
6580 3	3	5.8	19.9	2.2	2

Raccord Mod. 6580

Union Double Inégale

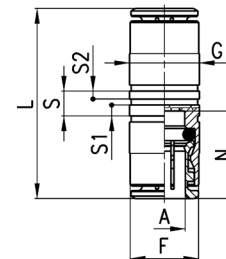

DIMENSIONS									
Mod.	A	F	G	L	N	S	S1	S2	Poids (g)
6580 4	4	8.4	9	29	14	5	2.2	1.6	11
6580 5	5	9.4	10	31	15	5	2.2	1.6	15
6580 6	6	11.7	12	34	16	5	2.2	1.6	16
6580 8	8	13.7	14	37	17.5	5	2.2	1.6	23
6580 10	10	15.4	17	41.5	20.2	5	2.2	1.6	33
6580 12	12	18.3	19	39.5	19.2	5.2	2.2	1.6	40
6580 14	14	20.5	21	41.5	20.2	5.2	2.2	1.6	47
6580 16	16	-	47	47	23	-	-	-	60

Raccord Mod. 6580 - Unions inégales

Union Double Inégale

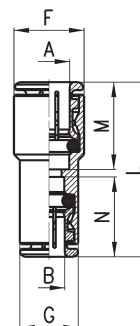

DIMENSIONS								
Mod.	A	B	F	G	L	M	N	Poids (g)
6580 6-4	6	4	12	9	31.5	16	14	12
6580 8-6	8	6	14	12.2	35	17.5	16	19
6580 10-8	10	8	16	14	39	20	17.5	25
6580 12-10	12	10	19	16	40.5	19	20	35

Raccord Mod. 6593

Droit Femelle Traversée de Cloison Cylindrique

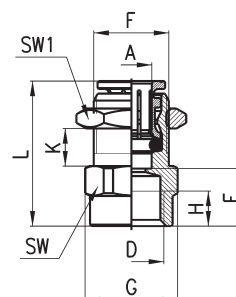

DIMENSIONS												
Mod.	A	D	E	F	G	H	L	K (max)	K (min)	SW	SW1	Poids (g)
6593 6-1/8	6	G1/8	10	M12x1	16.4	6	24.5	8.5	2	15	17	19
6593 6-1/4	6	G1/4	11.5	M12x1	18.5	7	26	6.5	2	17	17	22
6593 8-1/8	8	G1/8	10	M15x1	18.5	6	27	9.5	2	17	19	26
6593 8-1/4	8	G1/4	11.5	M15x1	18.5	7	28.5	9.5	2	17	19	26
6593 10-3/8	10	G3/8	12.8	M18x1	24.5	8	32.5	12	2	22	22	43

Raccord Mod. 6550 Micro

Coude Egal

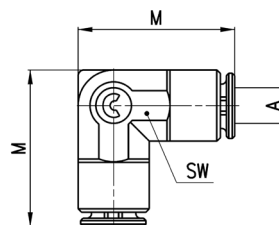

DIMENSIONS				
Mod.	A	M	SW	Poids (g)
6550 3	3	13.7	6	3

RACCORDS INSTANTANÉS POUR TUBE PLASTIQUE SÉRIE 6000

Raccord Mod. 6550

Coude Egal

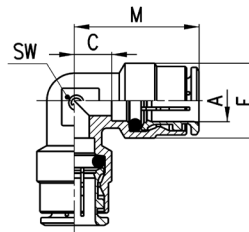

DIMENSIONS						
Mod.	A	C	F	M	SW	Poids (g)
6550 4	4	3.5	9	17.5	8	8
6550 5	5	5.5	10	20.5	9	15
6550 6	6	4	12.7	20	9	17
6550 8	8	5	14.2	22.5	11	22
6550 10	10	5.8	16.5	26	13	30
6550 12	12	7.3	19.5	26.5	15	44
6550 14	14	8.3	21.5	28.5	17	71

Raccord Mod. 6540 Micro

Té Egal

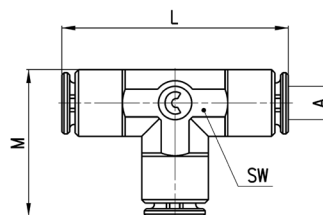

DIMENSIONS					
Mod.	A	L	M	SW	Poids (g)
6540 3	3	21.4	13.7	6	4

Raccord Mod. 6540

Té Egal

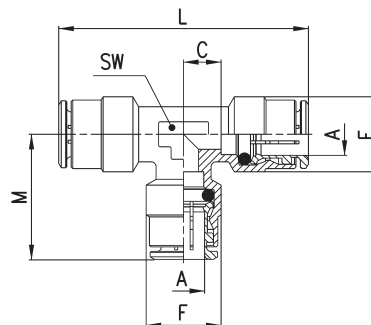

DIMENSIONS							
Mod.	A	C	F	L	M	SW	Poids (g)
6540 4	4	3.5	9	35	17.5	8	14
6540 5	5	5.5	10	41	20.5	9	21
6540 6	6	4	12.7	40	20	9	24
6540 8	8	5	14.2	45	22.5	11	32
6540 10	10	5.8	16.5	52	26	13	43
6540 12	12	7.3	19.5	53	26.5	15	60
6540 14	14	8.3	21.5	57	28.5	17	75

Raccord Mod. 6600



Croix Egal

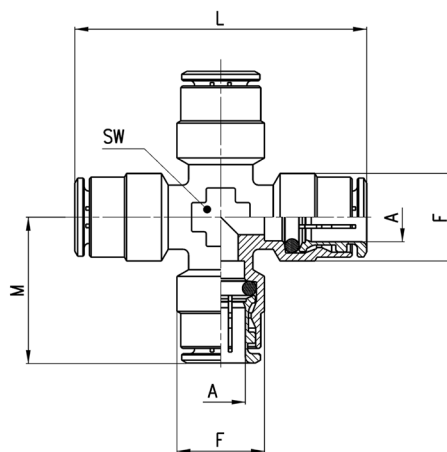

DIMENSIONS						
Mod.	A	F	L	M	SW	Poids (g)
6600 4	4	9	38	19	9	26
6600 5	5	10	41	20.5	9	29
6600 6	6	12.7	44	22	10	35
6600 8	8	14.2	49	24.5	12	50
6600 10	10	16.5	55	27.5	14	63
6600 12	12	19.5	56	28	16	84

Raccord Mod. 6560 Micro

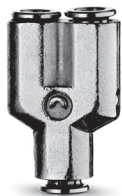

Y Egal

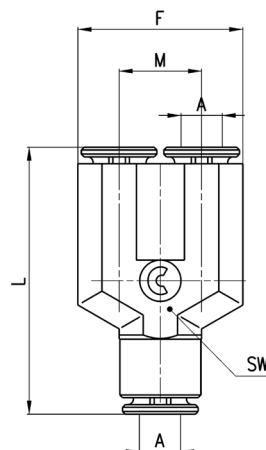

DIMENSIONS						
Mod.	A	F	L	M	SW	Poids (g)
6560 3	3	12	20.4	6	6	5

Raccord Mod. 6560



Y Egal

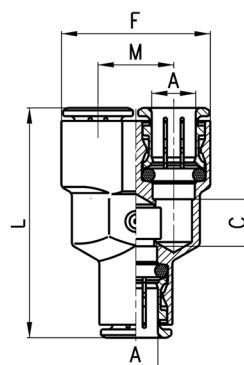

DIMENSIONS						
Mod.	A	C	F	L	M	Poids (g)
6560 4	4	5	18	33	9	19
6560 6	6	7	24.5	39	12.5	30
6560 8	8	9	28.5	44	14.5	42
6560 10	10	15.5	32	53.5	16	63

RACCORDS INSTANTANÉS POUR TUBE PLASTIQUE SÉRIE 6000

Raccord Mod. 6700

S* = pour siège métallique et
pour siège synthétique

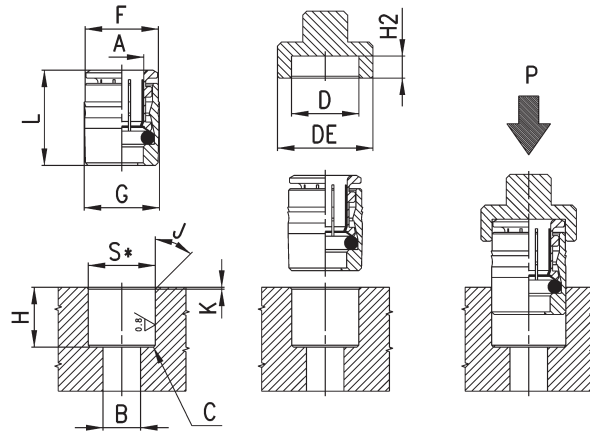

Mod.	A	B	C	D	DE	F	G	H	H2 (+0,1/0)	J	K	L	P min (Kg)	P max (Kg)	S (+0,01/-0,04)	Poids (g)
6700 3	3	2	0.5x45°	6.1	11	5.9	6.2	6.3	2.6	30°	0.3	9.2	80	350	6	1
6700 4	4	3.5	0.5x45°	8.8	14	8.6	9	11	3.3	15°	0.5	14.5	200	360	8.75	4
6700 5	5	3.5	0.5x45°	9.8	15	9.6	10	11.5	3.3	15°	0.5	15.5	230	450	9.75	5
6700 6	6	4	0.5x45°	12	17	11.8	12.2	12	3.8	15°	0.5	16.5	160	570	11.95	8
6700 8	8	6	0.5x45°	14	19	13.8	14.2	14	3.3	15°	0.5	18	140	400	13.95	11
6700 10	10	8	0.5x45°	16	21	15.8	16.2	16.5	3.5	15°	0.5	20.5	150	650	15.95	15

Raccord Mod. 6750

Bouchon Femelle

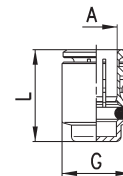

DIMENSIONS				
Mod.	A	G	L	Poids (g)
6750 4	4	8.8	15	4
6750 6	6	11.8	17	7
6750 8	8	13.8	18.5	9
6750 10	10	15.8	21	12
6750 12	12	17.8	20	15

Raccord Mod. 6850

Augmentation : Ø coté griffe > Ø embout mâle

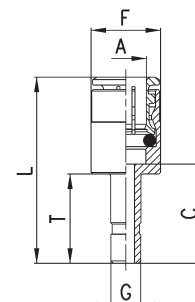

DIMENSIONS							
Mod.	A	G	C	F	L	T	Poids (g)
6850 6-4	6	4	17.5	12.7	33.5	16.5	11
6850 8-6	8	6	19	14	36.5	18	15

Raccord Mod. 6800



Réduction
Ø côté griffe < Ø embout mâle

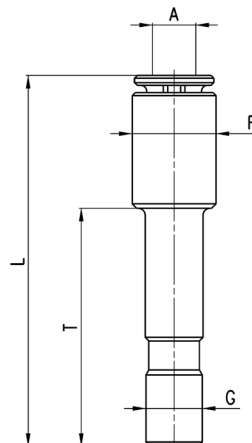

DIMENSIONS						
Mod.	A	F	G	L	T	Poids (g)
6800 3-4	3	5.8	4	26	16.5	2

RACCORDS INSTANTANÉS POUR TUBE PLASTIQUE SÉRIE 6000

Raccord Mod. 6800



Réduction : Ø coté griffe < Ø embout mâle

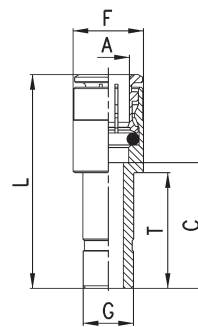

DIMENSIONS							
Mod.	A	G	C	F	L	T	Poids (g)
6800 4-5	4	5	19	9	33	18	8
6800 4-6	4	6	15.5	9	29.5	18	9
6800 4-8	4	8	18	9	32	20.5	10
6800 5-6	5	6	19	10	34	18	11
6800 5-8	5	8	18	10	33	20.5	12
6800 6-8	6	8	18	12.7	34	20.5	12
6800 6-10	6	10	20.5	12.7	36.5	23	17
6800 6-12	6	12	17.5	12.7	33.5	24	21
6800 8-10	8	10	20.5	14	38	23	15
6800 8-12	8	12	21.5	14	39	24	22
6800 10-12	10	12	20.3	16.5	40.5	24	27
6800 10-14	10	14	24.3	16.5	44.5	28	33
6800 12-14	12	14	24.3	18.8	45.5	28	27

Raccord Mod. 6950



Jonction Egale

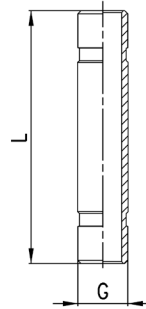

DIMENSIONS			
Mod.	G	L	Poids (g)
6950 4	4	32.5	3
6950 6	6	35.5	4
6950 8	8	40.5	7
6950 10	10	46	10
6950 12	12	48	13
6950 14	14	52	17

Raccord Mod. 6555



Coude Egal Mâle/Femelle

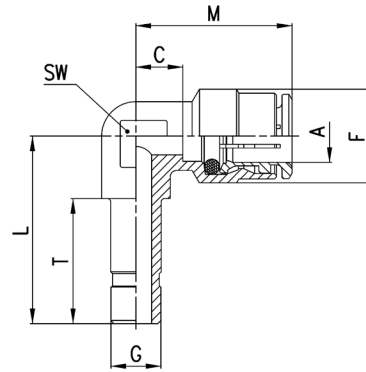

DIMENSIONS									
Mod.	A	G	C	L	F	T	M	SW	Poids (g)
6555 4-4	4	4	3.5	22	9	16.5	17.5	9	8
6555 6-6	6	6	4	24.5	12.7	18	20	9	14
6555 8-8	8	8	5	27.5	14.2	20	22.5	11	21
6555 10-10	10	10	5.8	32	16.5	23	26	13	26

Raccord Mod. 6708



Capuchon de Protection
Couleur: noire
Matériau auto extinguable
Classe V0

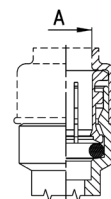
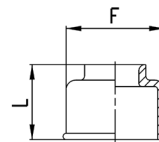

DIMENSIONS				
Mod.	A	F	L	Poids (g)
6708 4	4	10.7	10.7	1
6708 5	5	11.7	11	1
6708 6	6	13.7	11.5	1
6708 8	8	15.7	12.5	1
6708 10	10	18.5	13	1
6708 12	12	20.7	15	2
6708 14	14	23.7	15	2

Bouchon Mod. 6900 Micro



Bouchon Mâle en plastique

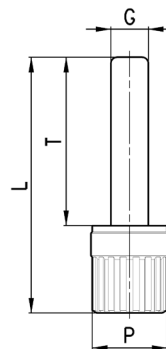

DIMENSIONS					
Mod.	G	L	P	T	Poids (g)
6900 3	3	20.5	6	13.5	1

Bouchon Mod. 6900



Bouchon Mâle en plastique

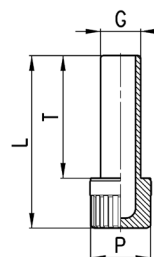

DIMENSIONS					
Mod.	G	L	P	T	Poids (g)
6900 4	4	29	8	20	1
6900 5	5	29.5	8	20.5	1
6900 6	6	31.5	8	22.5	1
6900 8	8	34.5	12	24.5	2
6900 10	10	37	12	27	2
6900 12	12	40.5	16	28.5	3
6900 14	14	42.5	16	30.5	3

Jeu de clés Mod. SP



Jeu de Clés permettant la déconnexion de tubes de 4 à 12 mm.

Matériau : plastique

RACCORDS INSTANTANÉS POUR TUBE PLASTIQUE SÉRIE 6000